



# PROTON-ELECTROTEX RUSSIA

High forward current capability  
 Low forward losses  
 Low thermal resistance  
 High load cycle capability

## Rectifier Diode For Welding Type D053-7100-4-N

Average forward current	$I_{FAV}$	7402 A
Repetitive peak reverse voltage	$V_{RRM}$	200 ÷ 400 V
$V_{RRM}, V$	200	400
Voltage code	2	4
$T_j, ^\circ C$	- 60 ÷ 170	

### MAXIMUM ALLOWABLE RATINGS

Symbols and parameters	Units	Values	Test conditions
<b>ON-STATE</b>			
$I_{FAV}$	Average forward current	A	7100 7402
			$T_c = 89,8 ^\circ C$ ; Double side cooled; $T_c = 85 ^\circ C$ ; Double side cooled; 180° half-sine wave; 50 Hz
$I_{FRMS}$	RMS forward current	A	11147
			$T_c = 89,8 ^\circ C$ ; Double side cooled; 180° half-sine wave; 50 Hz
$I_{FSM}$	Surge forward current	kA	55.0
			63.0
			$T_j = T_{jmax}$ $T_j = 25 ^\circ C$ 180° half-sine wave; 50 Hz ( $t_p = 10$ ms); single pulse; $V_R = 0$ V;
$I^2t$	Safety factor	$A^2s \cdot 10^3$	58.0
			67.0
			$T_j = T_{jmax}$ $T_j = 25 ^\circ C$ 180° half-sine wave; 60 Hz ( $t_p = 8.3$ ms); single pulse; $V_R = 0$ V;
$I^2t$	Safety factor	$A^2s \cdot 10^3$	15125
			19845
			$T_j = T_{jmax}$ $T_j = 25 ^\circ C$ 180° half-sine wave; 50 Hz ( $t_p = 10$ ms); single pulse; $V_R = 0$ V;
$I^2t$	Safety factor	$A^2s \cdot 10^3$	13960
			18625
			$T_j = T_{jmax}$ $T_j = 25 ^\circ C$ 180° half-sine wave; 60 Hz ( $t_p = 8.3$ ms); single pulse; $V_R = 0$ V;
<b>BLOCKING</b>			
$V_{RRM}$	Repetitive peak reverse voltages	V	200 ÷ 400
			$T_{jmin} < T_j < T_{jmax}$ ; 180° half-sine wave; 50 Hz;
$V_{RSM}$	Non-repetitive peak reverse voltages	V	300 ÷ 500
			$T_{jmin} < T_j < T_{jmax}$ ; 180° half-sine wave; 50 Hz; single pulse;
$V_R$	Reverse continuous voltages	V	$0.75 \cdot V_{RRM}$
			$T_j = T_{jmax}$ ;
<b>THERMAL</b>			
$T_{stg}$	Storage temperature	$^\circ C$	- 60 ÷ 170
$T_j$	Operating junction temperature	$^\circ C$	- 60 ÷ 170
<b>MECHANICAL</b>			
F	Mounting force	kN	30.0 ÷ 36.0
a	Acceleration	$m/s^2$	50
			100
			Device unclamped Device clamped

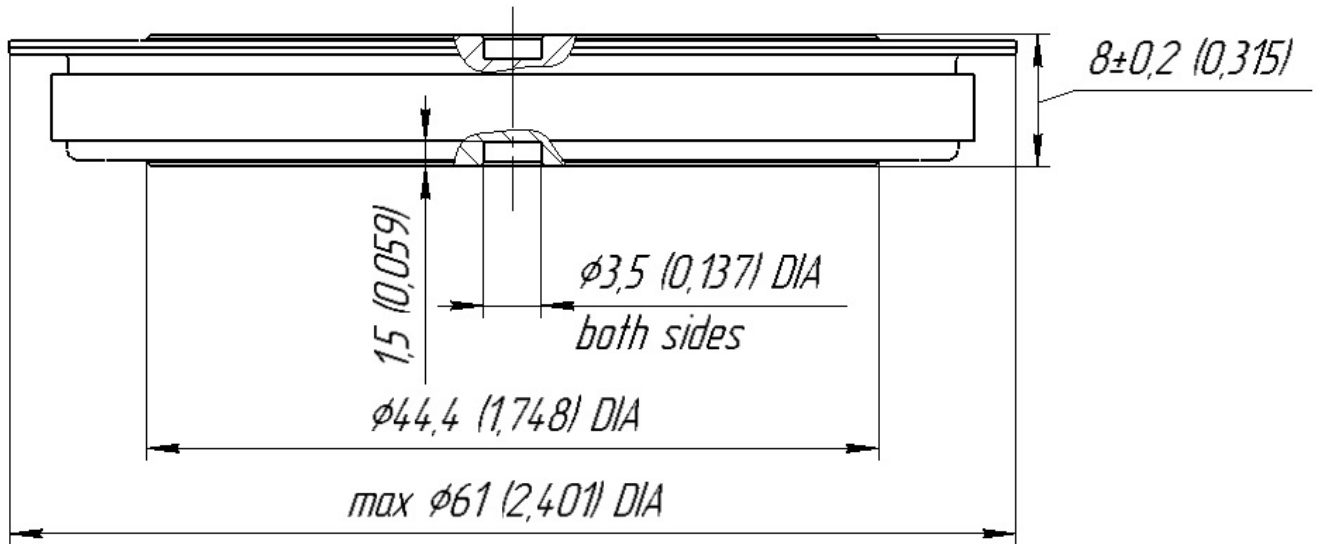
## CHARACTERISTICS

Symbols and parameters		Units	Values	Conditions	
<b>ON-STATE</b>					
$V_{FM}$	Peak forward voltage, max	V	1.05 0.89	$T_j=25\text{ }^\circ\text{C}; I_{FM} = 5000\text{ A}$ $T_j=T_{j\text{ max}}; I_{FM} = 5000\text{ A}$	
$V_{F(TO)}$	Forward threshold voltage, max	V	0.750	$T_j=T_{j\text{ max}};$	
$r_T$	Forward slope resistance, max	m $\Omega$	0.029	$5000\text{ A} < I_T < 14000\text{ A}$	
<b>BLOCKING</b>					
$I_{RRM}$	Repetitive peak reverse current, max	mA	50	$T_j=T_{j\text{ max}};$ $V_R=V_{RRM}$	
<b>SWITCHING</b>					
$Q_{rr}$	Total recovered charge, max	$\mu\text{C}$	950	$T_j=T_{j\text{ max}}; I_{FM}=1000\text{ A};$ $di_{FM}/dt=-30\text{ A}/\mu\text{s}$	
			620	$T_j=T_{j\text{ max}}; I_{FM}=1000\text{ A};$ $di_{FM}/dt=-10\text{ A}/\mu\text{s}$	
<b>THERMAL</b>					
$R_{thjc}$	Thermal resistance, junction to case, max	$^\circ\text{C}/\text{W}$	0.0090	Direct current	Double side cooled
$R_{thjc-A}$			0.0210		Anode side cooled
$R_{thjc-K}$			0.0160		Cathode side cooled
$R_{thck}$	Thermal resistance, case to heatsink, max	$^\circ\text{C}/\text{W}$	0.0050	Direct current	
<b>MECHANICAL</b>					
w	Weight, typ	g	140		
$D_s$	Surface creepage distance	mm (inch)	7.3 (0.287)		
$D_a$	Air strike distance	mm (inch)	4.0 (0.157)		

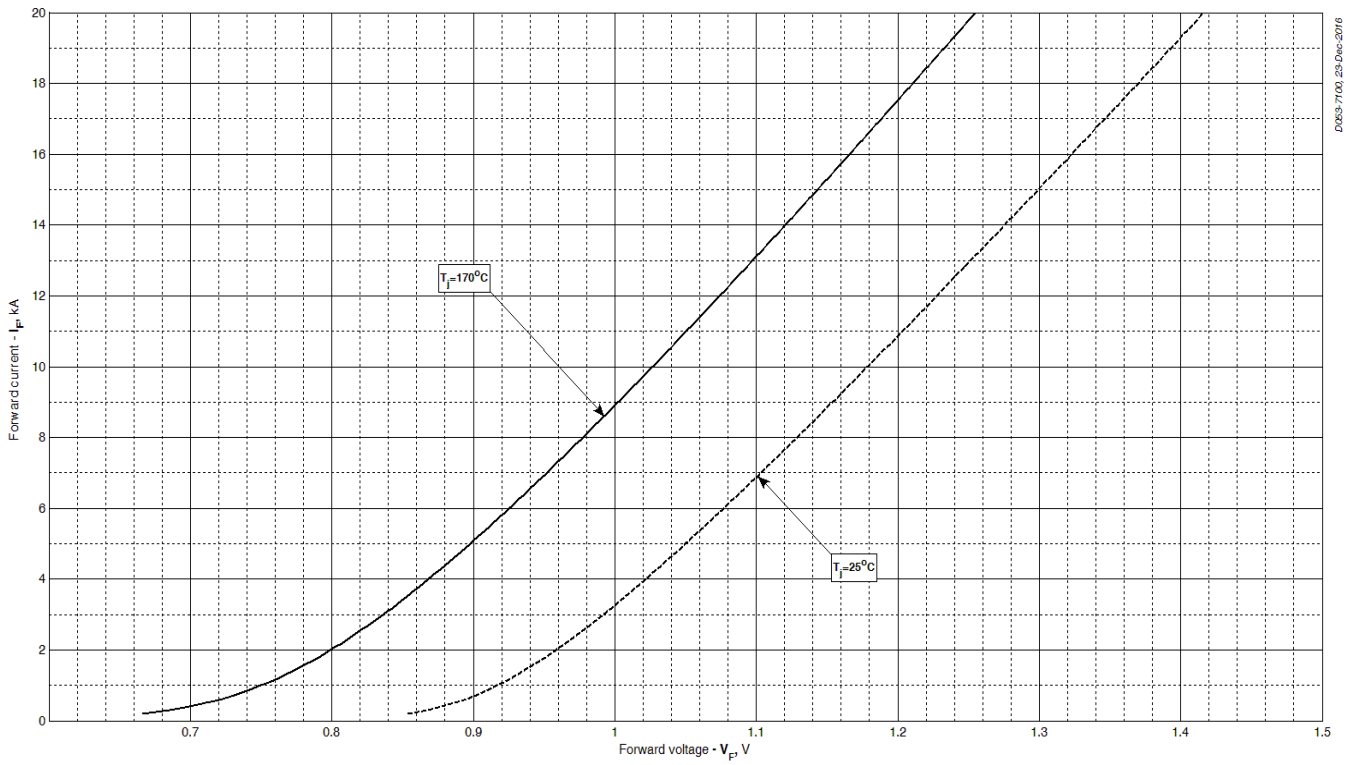
### PART NUMBERING GUIDE

D	053	7100	4	N
1	2	3	4	

1. Design version
2. Average forward current, A
3. Voltage code
4. Ambient conditions: N – normal



All dimensions in millimeters (inches)



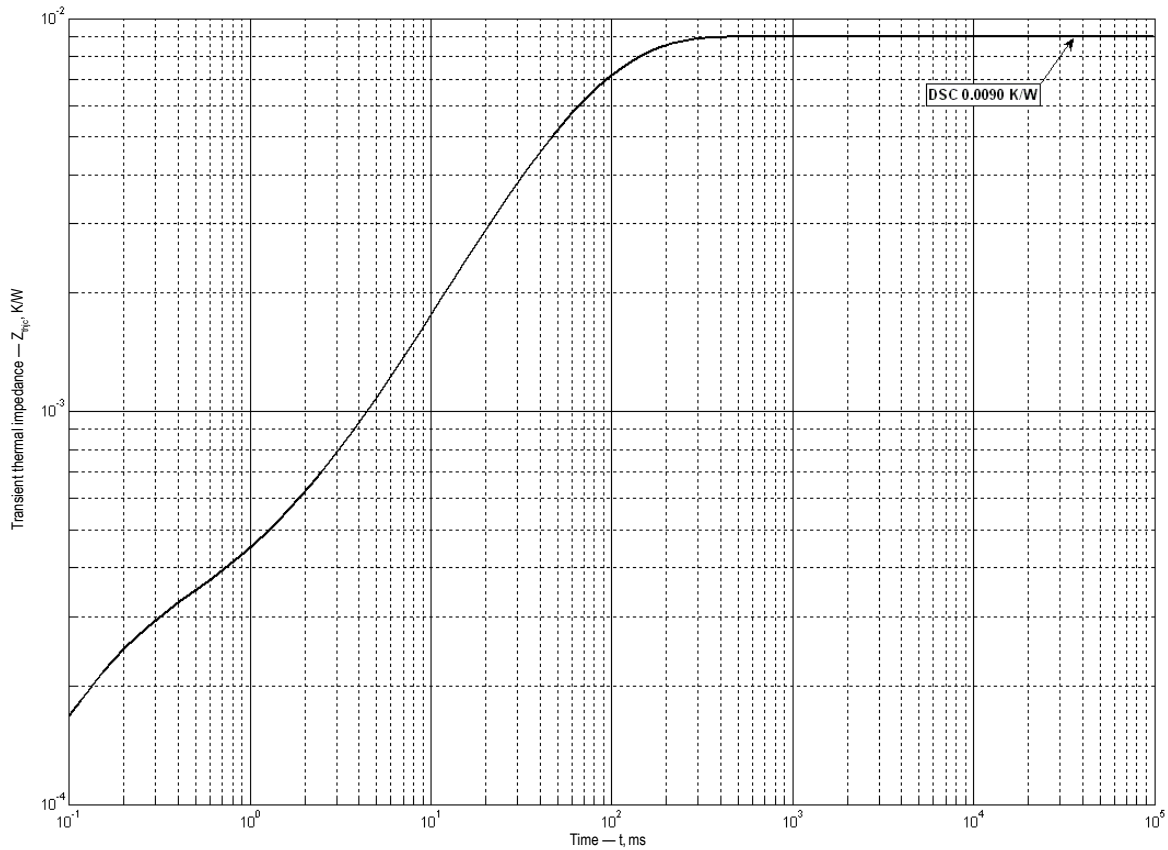
**Fig 1 – Forward characteristics of Limit device**

Analytical function for Forward characteristic:

$$V_F = A + B \cdot i_F + C \cdot \ln(i_F + 1) + D \cdot \sqrt{i_F}$$

	Coefficients for max curves	
	$T_j = 25^\circ\text{C}$	$T_j = T_{j \max}$
<b>A</b>	0.869879	0.692620
<b>B</b>	0.022542	0.021003
<b>C</b>	0.074643	0.110962
<b>D</b>	-0.029819	-0.044329

**Forward characteristic model (see Fig. 1).**



**Fig 2 – Transient thermal impedance**

Analytical function for Transient thermal impedance junction to case  $Z_{thjc}$  for DC:

$$Z_{thjc} = \sum_{i=1}^n R_i \left( 1 - e^{-\frac{t}{\tau_i}} \right)$$

Where  $i = 1$  to  $n$ ,  $n$  is the number of terms in the series.

$t$  = Duration of heating pulse in seconds.

$Z_{thjc}$  = Thermal resistance at time  $t$ .

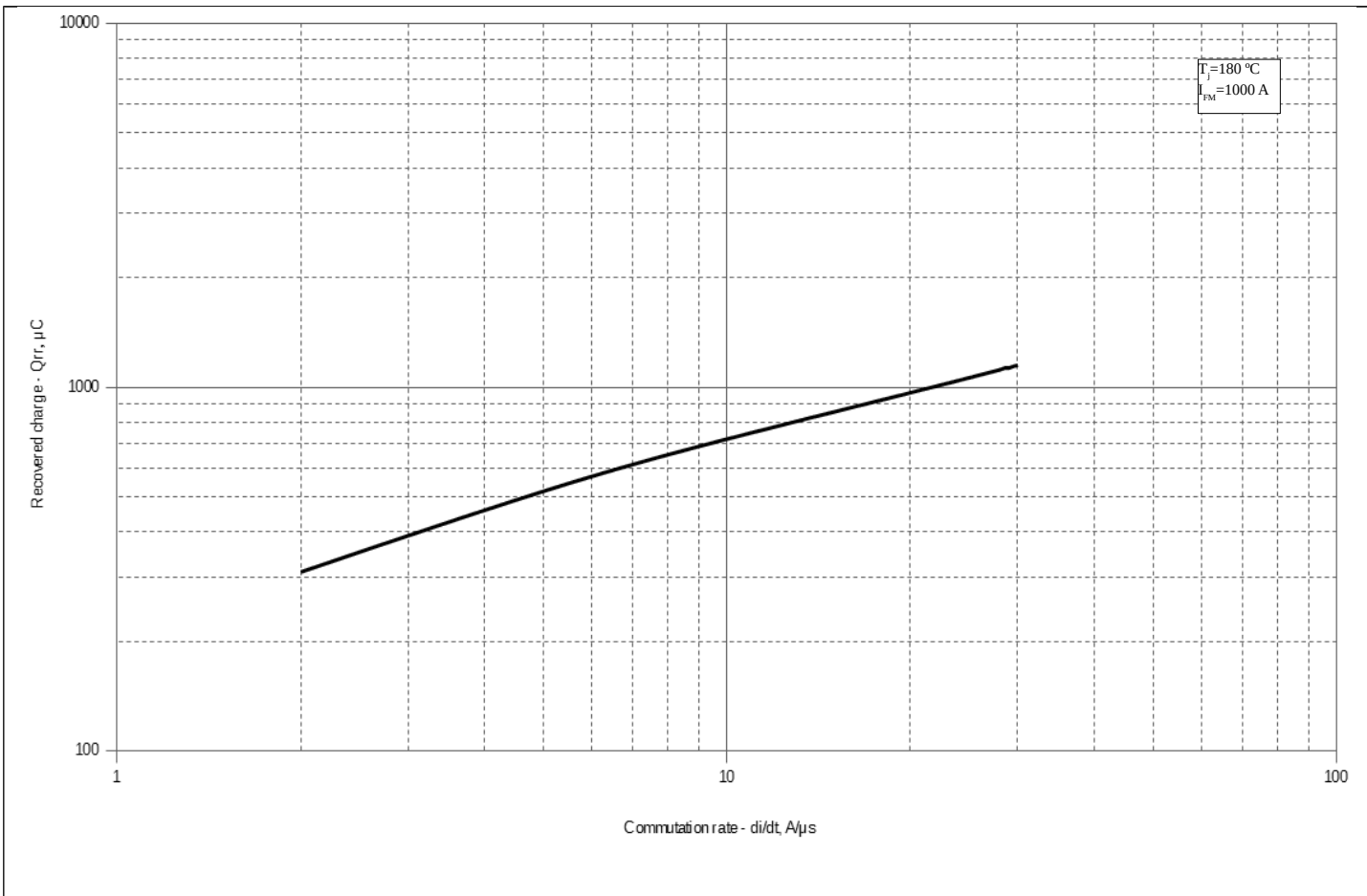
$R_i$  = Amplitude of  $p_{th}$  term.

$\tau_i$  = Time constant of  $r_{th}$  term.

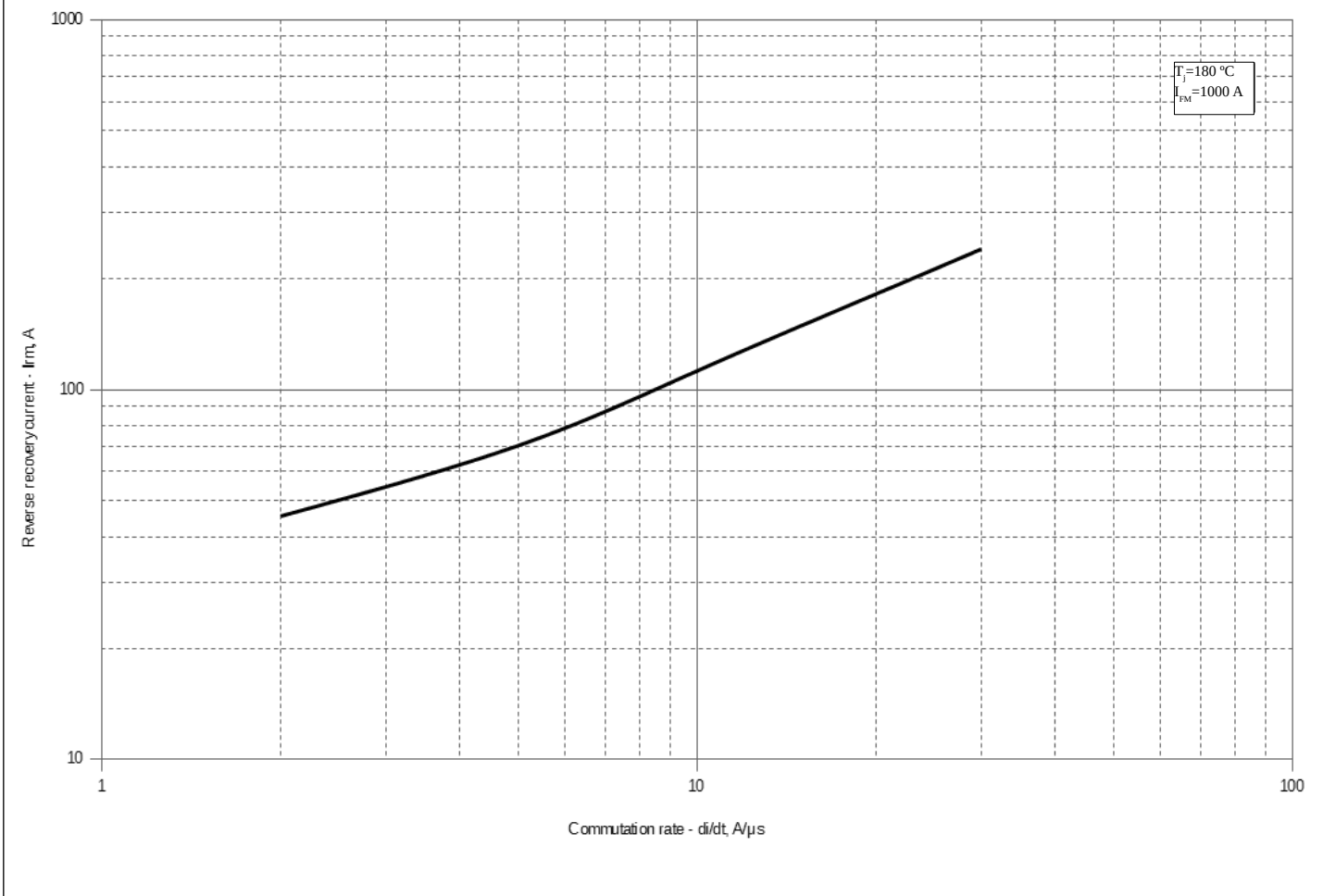
DC Double side cooled

<b>i</b>	<b>1</b>	<b>2</b>	<b>3</b>	<b>4</b>	<b>5</b>	<b>6</b>
<b><math>R_i</math>, K/W</b>	0.001448	0.006594	0.0006431	0.00004826	0.00004138	0.0002254
<b><math>\tau_i</math>, s</b>	0.08908	0.06263	0.01451	0.00151	0.0003338	0.0001058

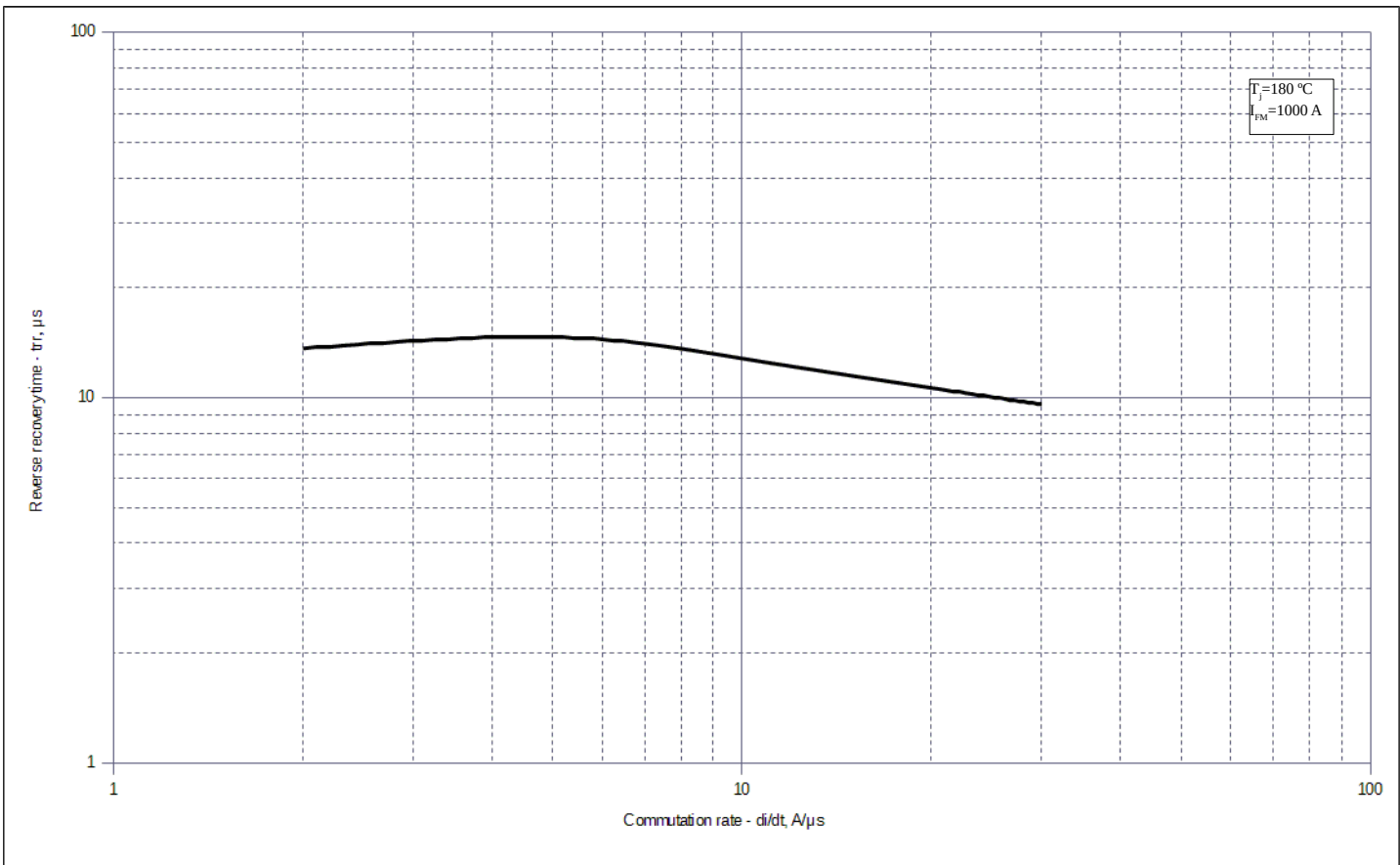
**Transient thermal impedance junction to case  $Z_{thjc}$  model (see Fig. 2)**



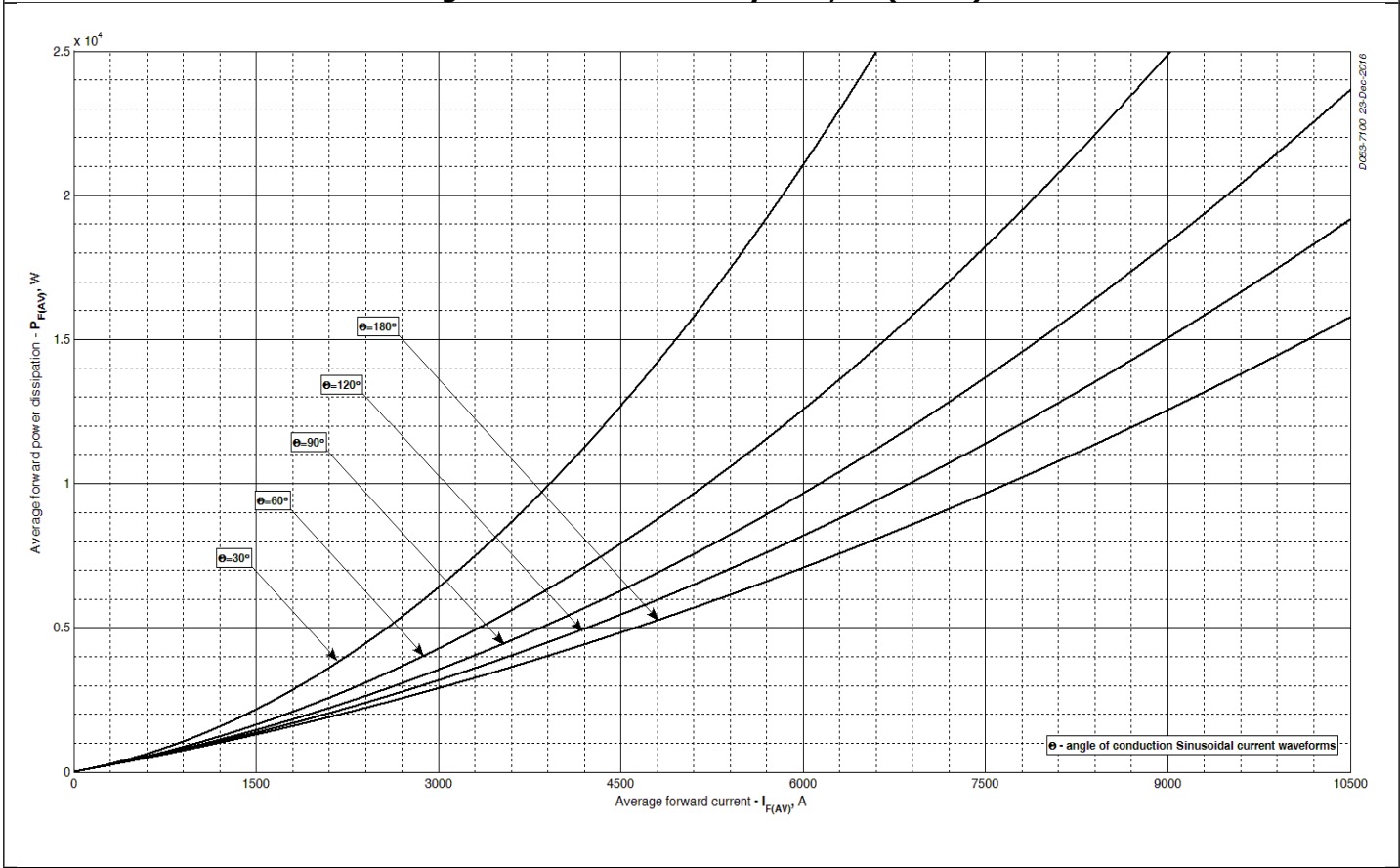
**Fig 3 - Recovered charge,  $Q_{rr}$**



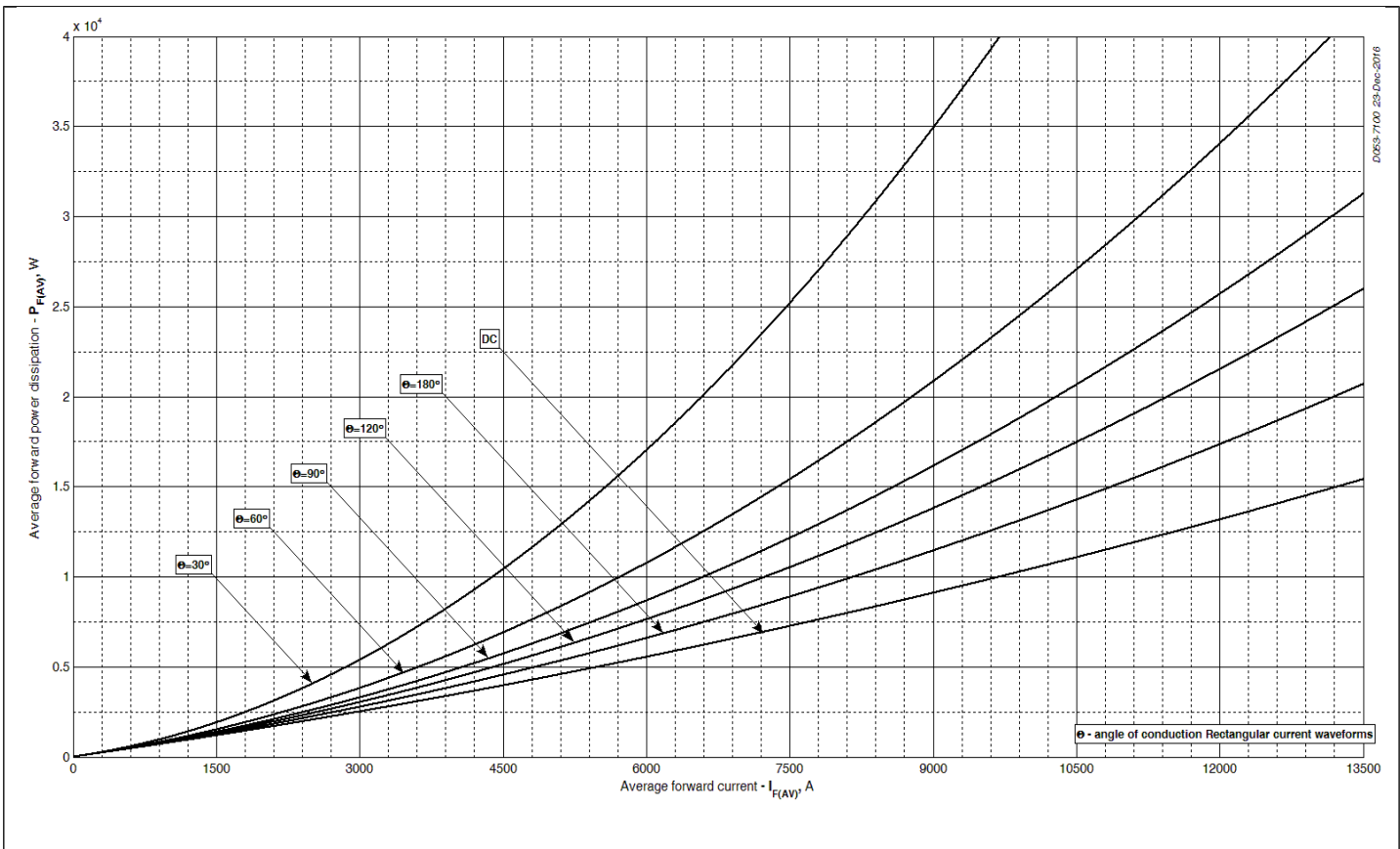
**Fig 4 – Peak reverse recovery current,  $I_{rm}$**



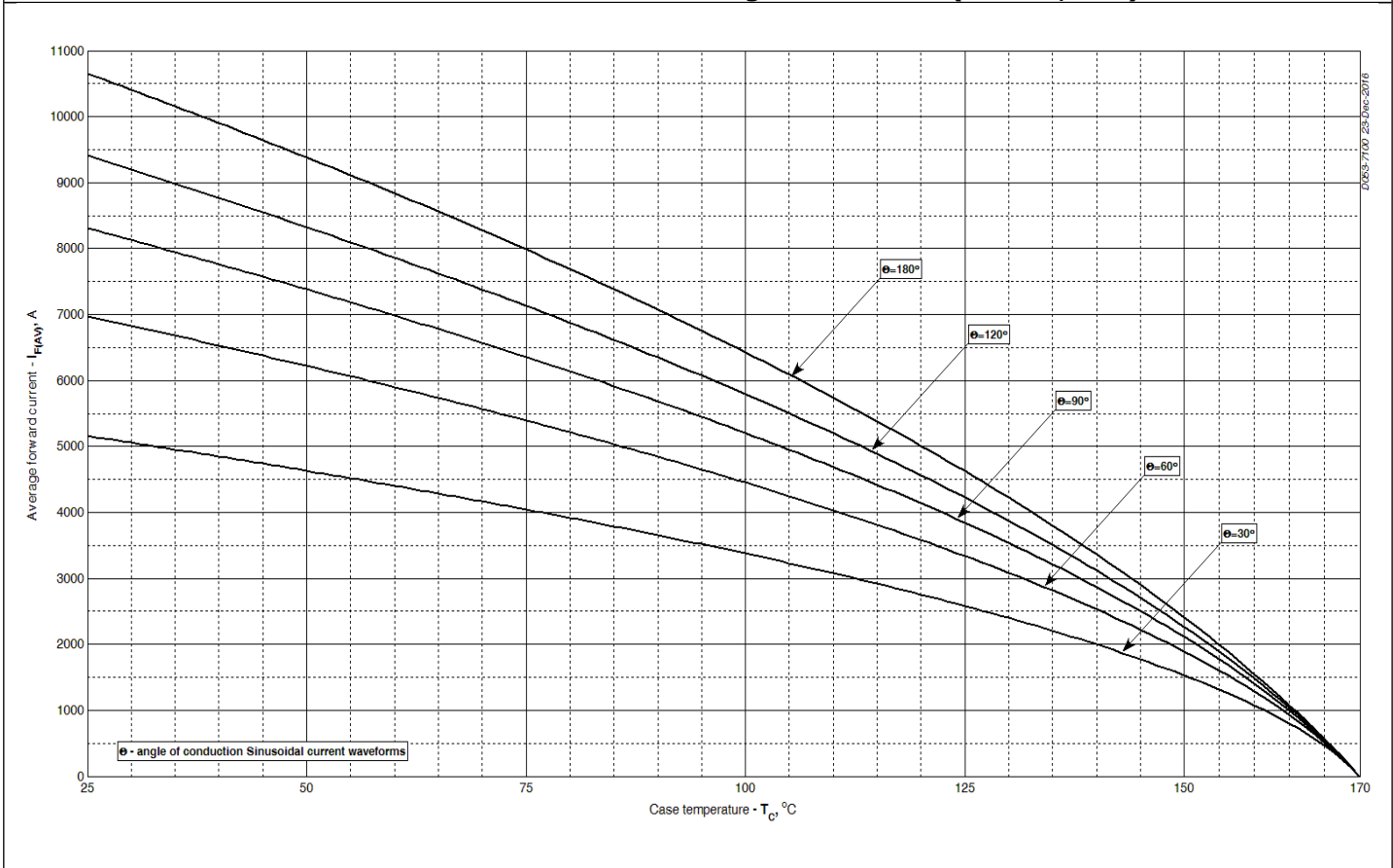
**Fig 5 – Maximum recovery time,  $t_{rr}$  (linear)**



**Fig 6 – Mean forward power dissipation  $P_{FAV}$  vs. Mean forward current  $I_{FAV}$  for sinusoidal current waveforms at different conduction angles ( $f=50\text{Hz}$ , DSC)**

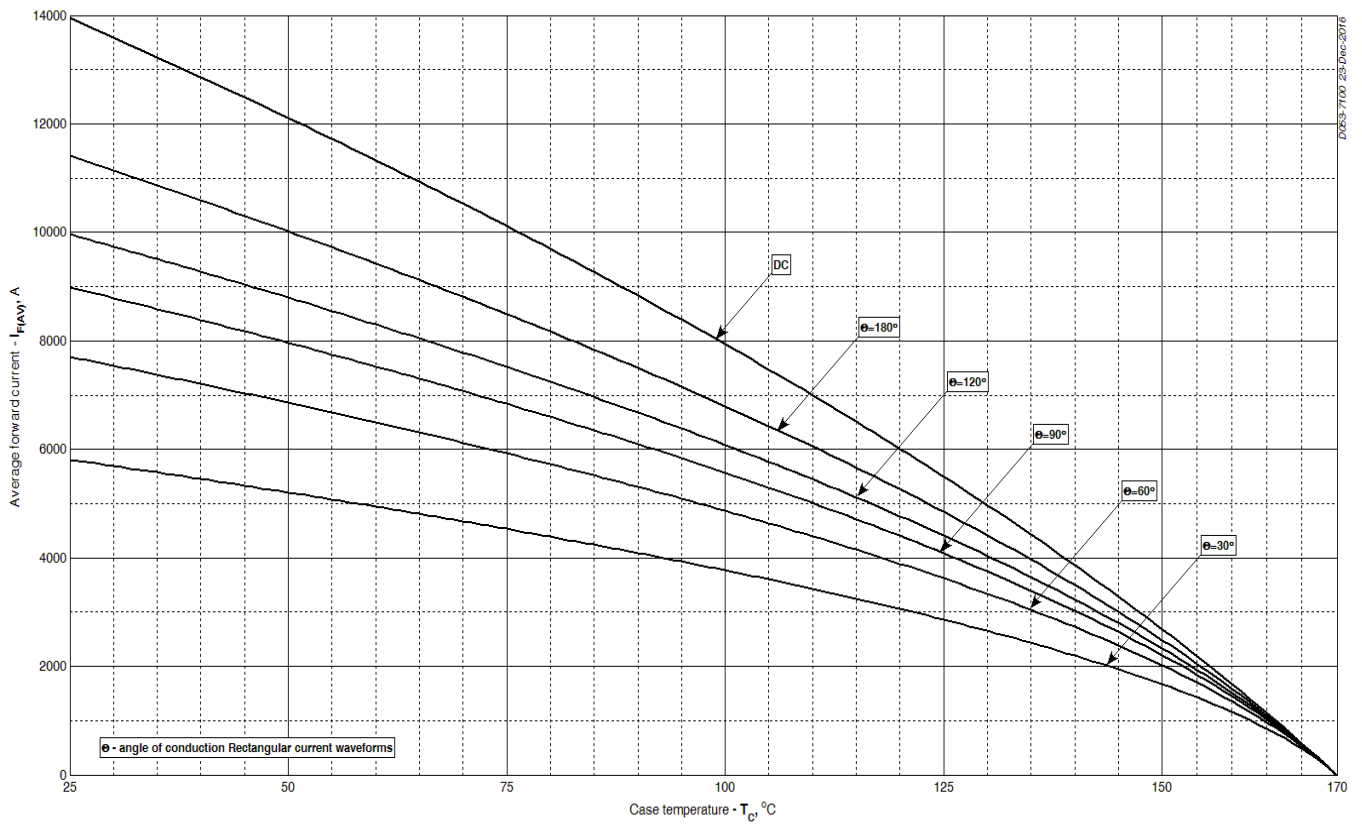


**Fig 7 – Mean forward power dissipation  $P_{FAV}$  vs. Mean forward current  $I_{FAV}$  for rectangular current waveforms at different conduction angles and for DC ( $f=50\text{Hz}$ , DSC)**

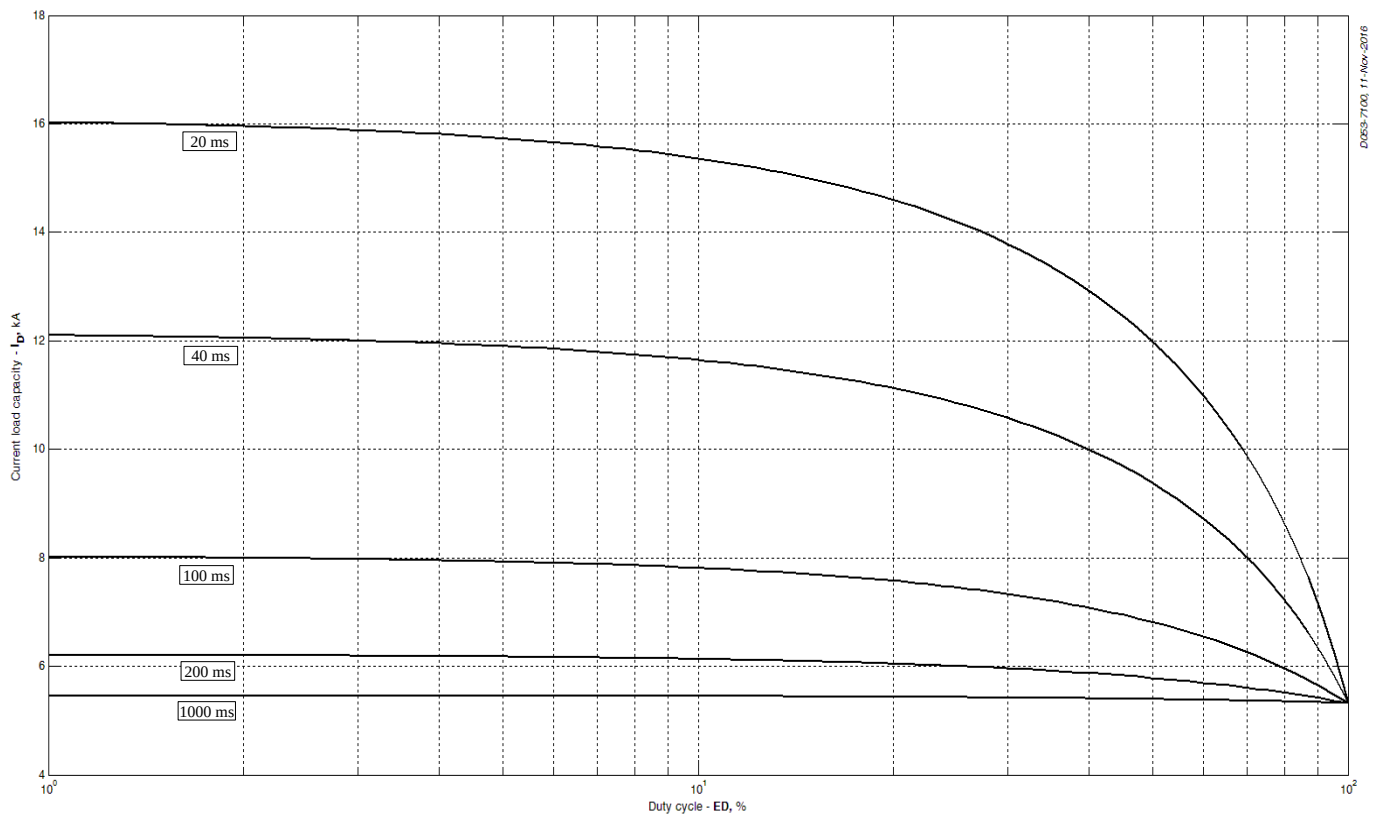


**Fig 8 - Mean forward current  $I_{FAV}$  vs. Case temperature  $T_C$  for sinusoidal current waveforms at different conduction angles ( $f=50\text{Hz}$ , DSC)**

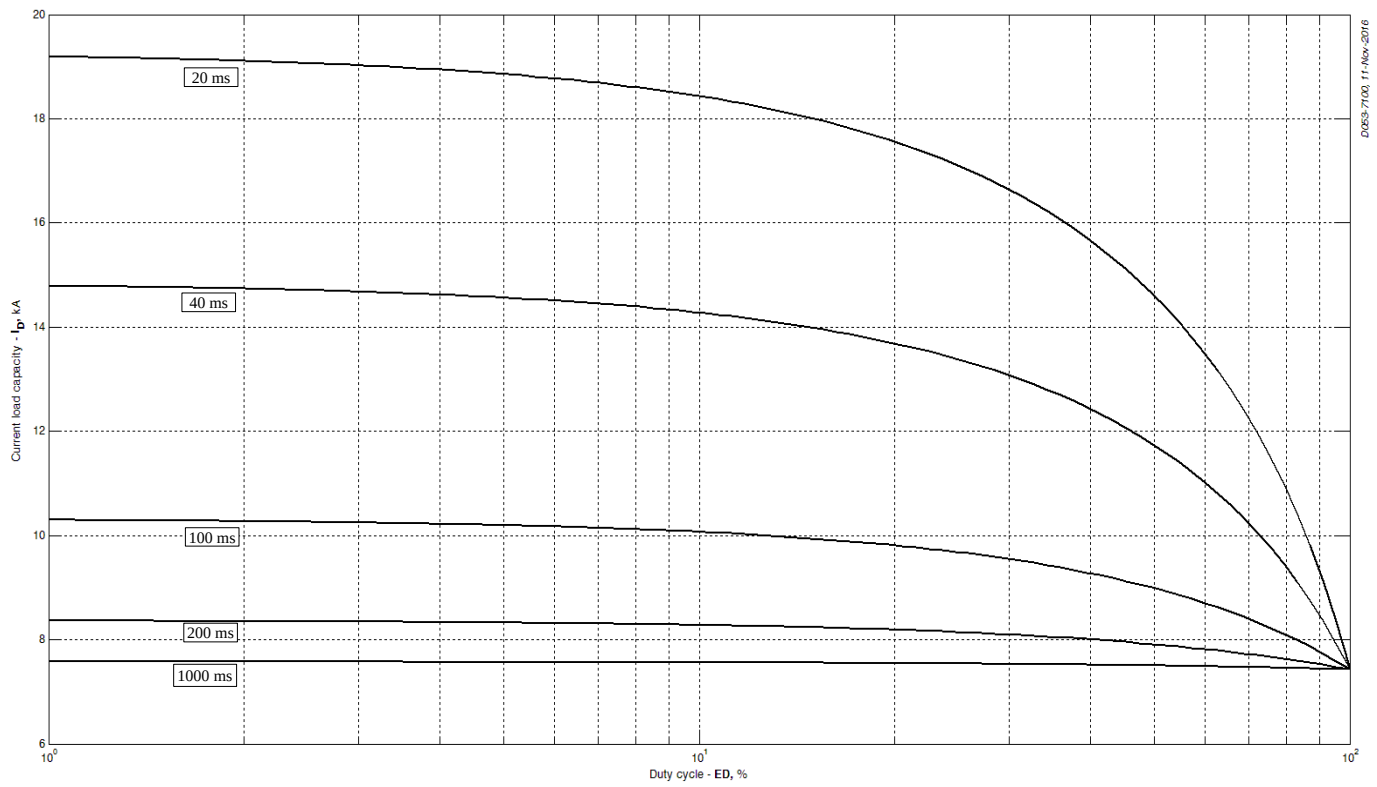




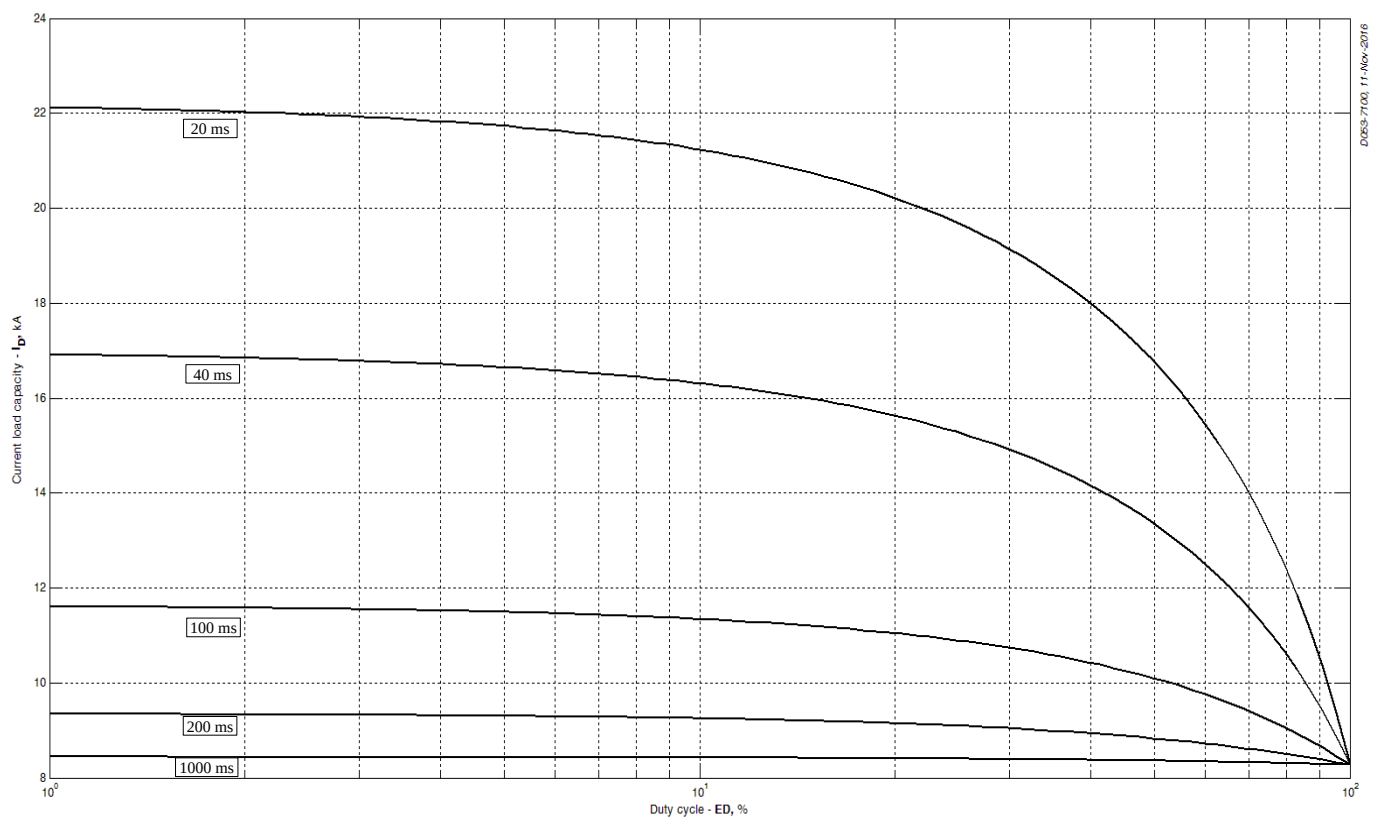
**Fig 9 – Mean forward current  $I_{FAV}$  vs. Case temperature  $T_C$  for rectangular current waveforms at different conduction angles and for DC ( $f=50\text{Hz}$ , DSC)**



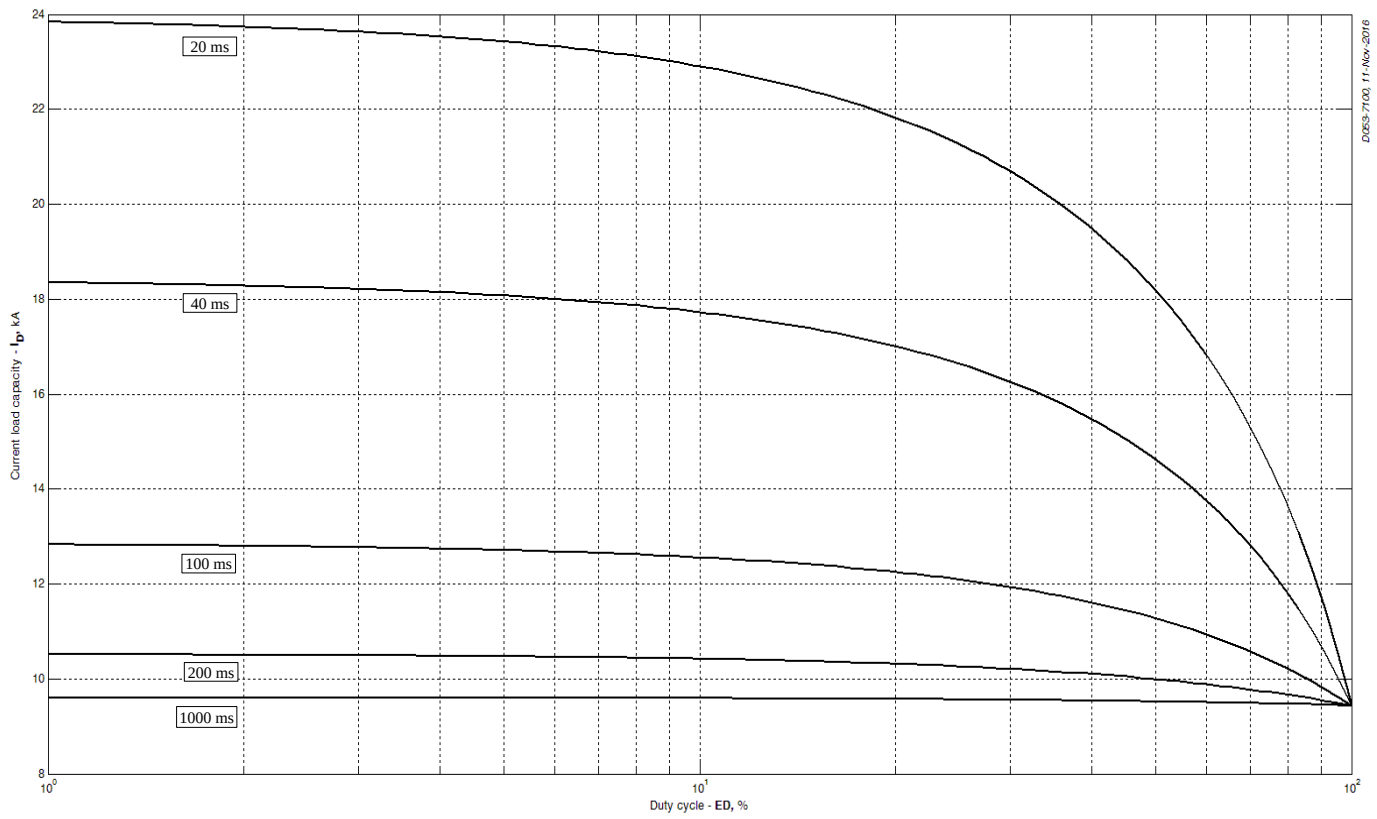
**Fig 10 – Current load capability ( $f=1000\text{ Hz}$ , square wave,  $T_C = 40\text{ }^\circ\text{C}$ )**



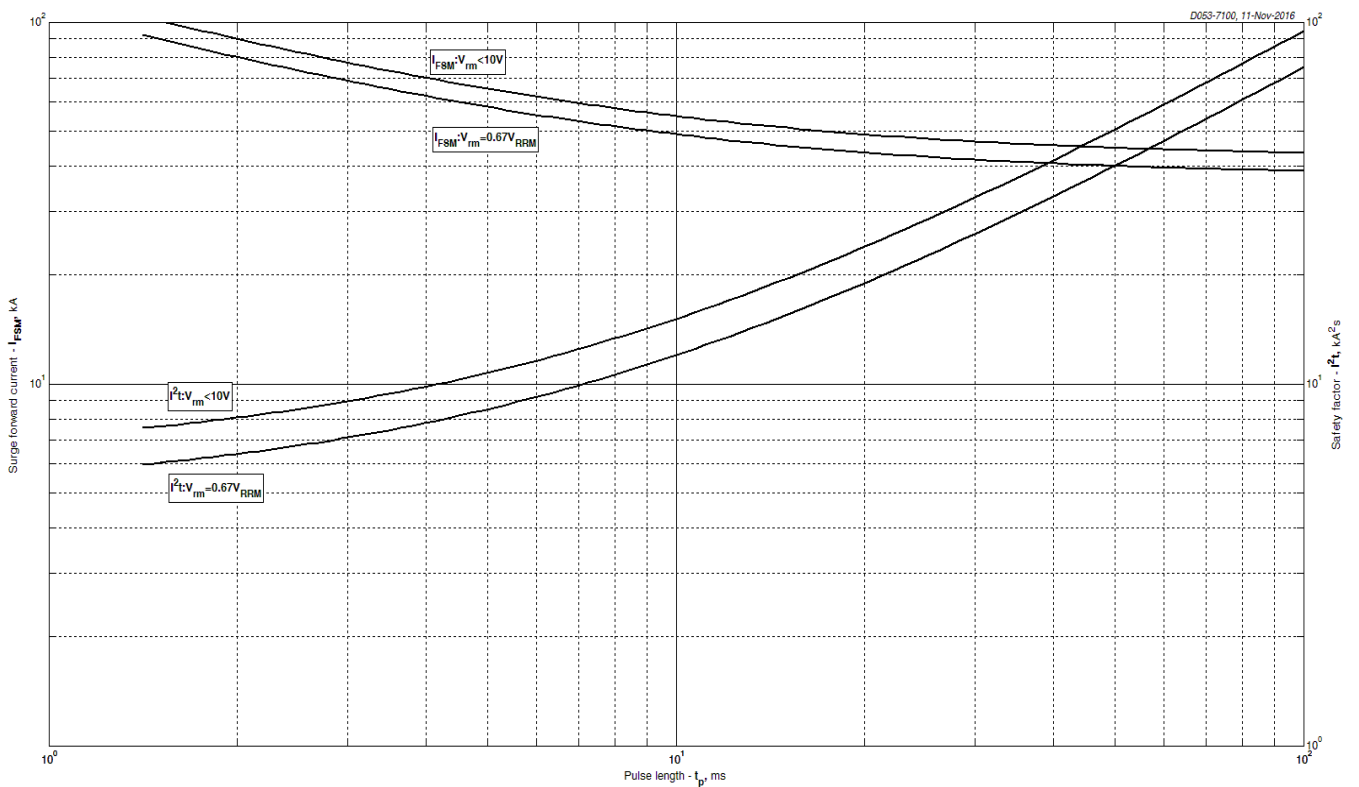
**Fig 11 – Current load capability (f=1000 Hz, square wave, T<sub>c</sub> = 60 °C)**



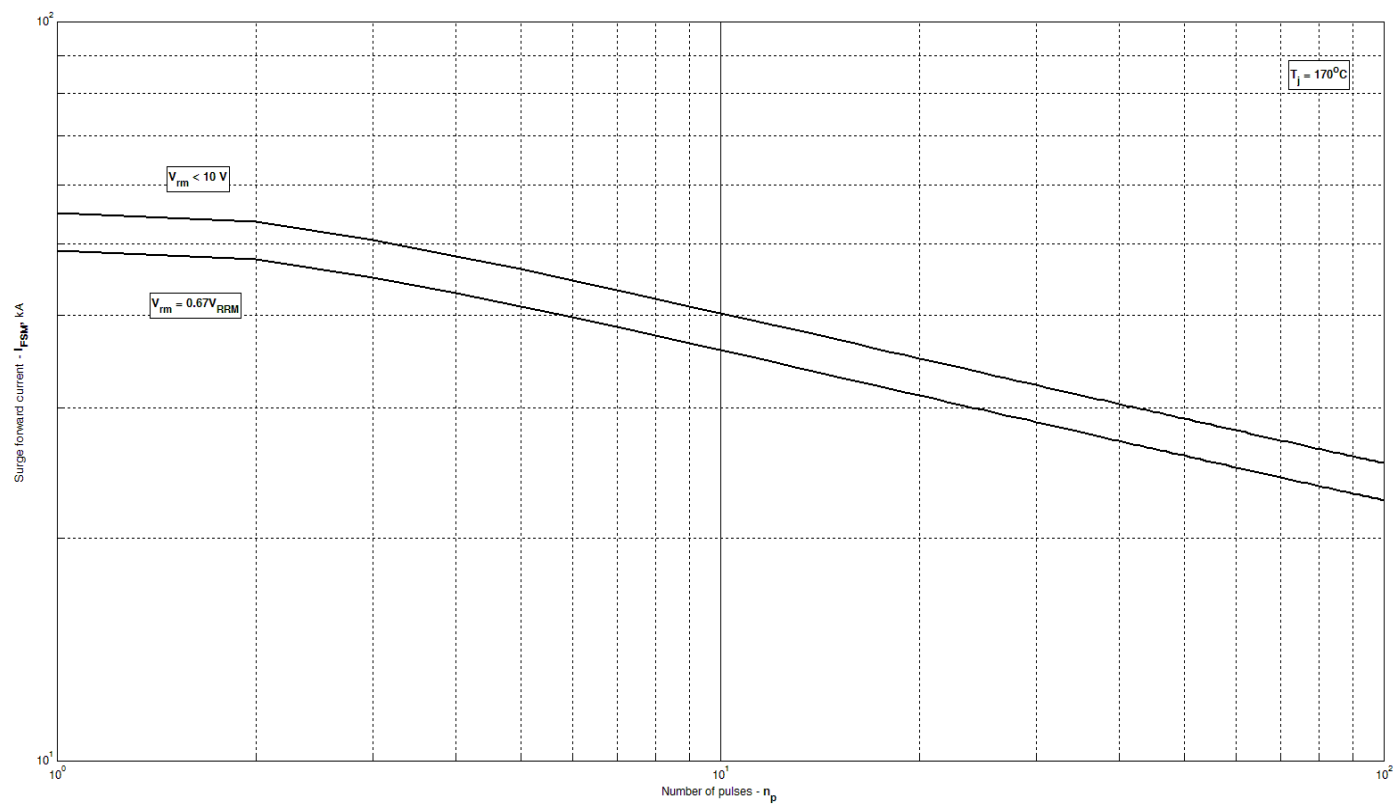
**Fig 12 – Current load capability (f=1000 Hz, square wave, T<sub>c</sub> = 70 °C)**



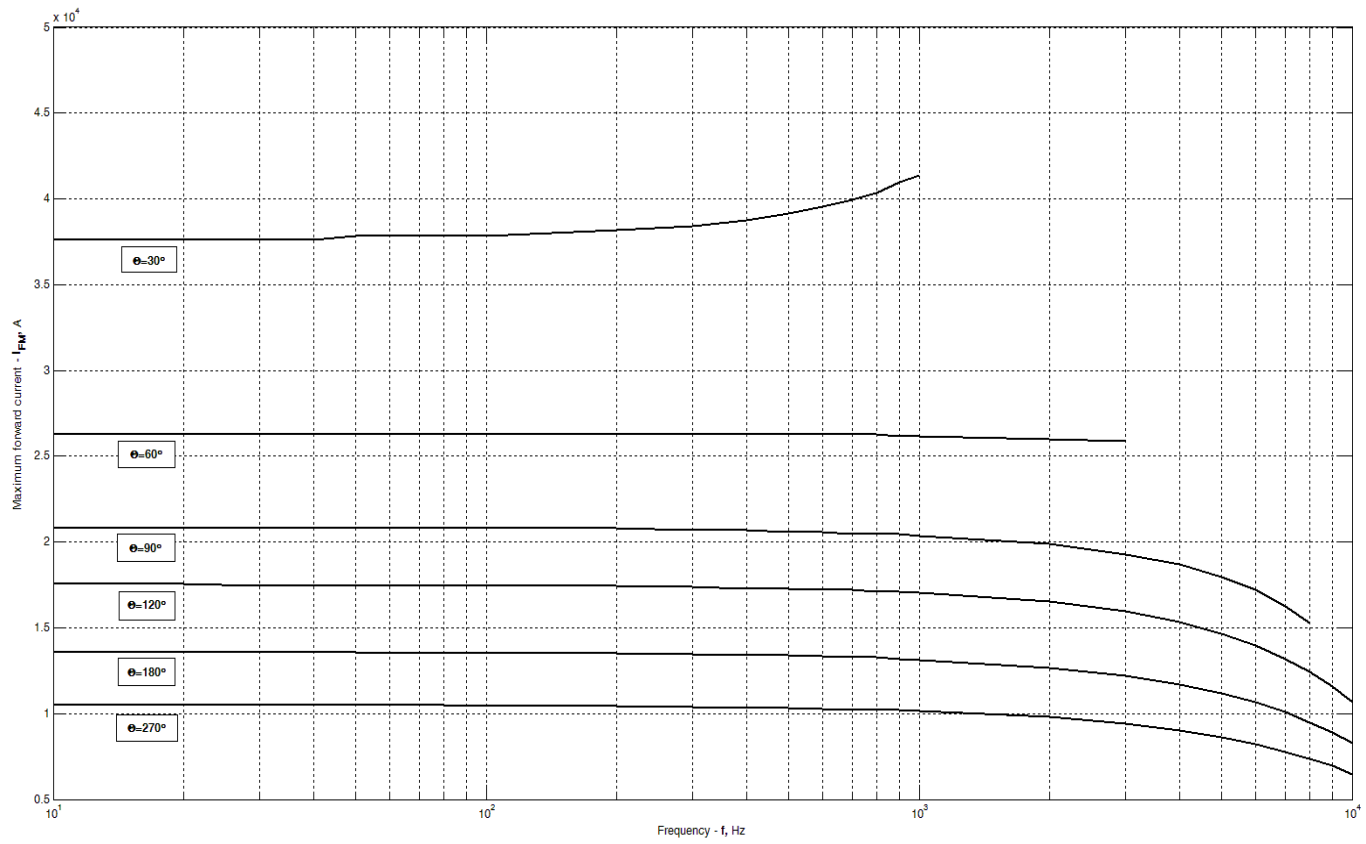
**Fig 13 – Current load capability (f=1000 Hz, square wave,  $T_c = 80\text{ }^\circ\text{C}$ )**



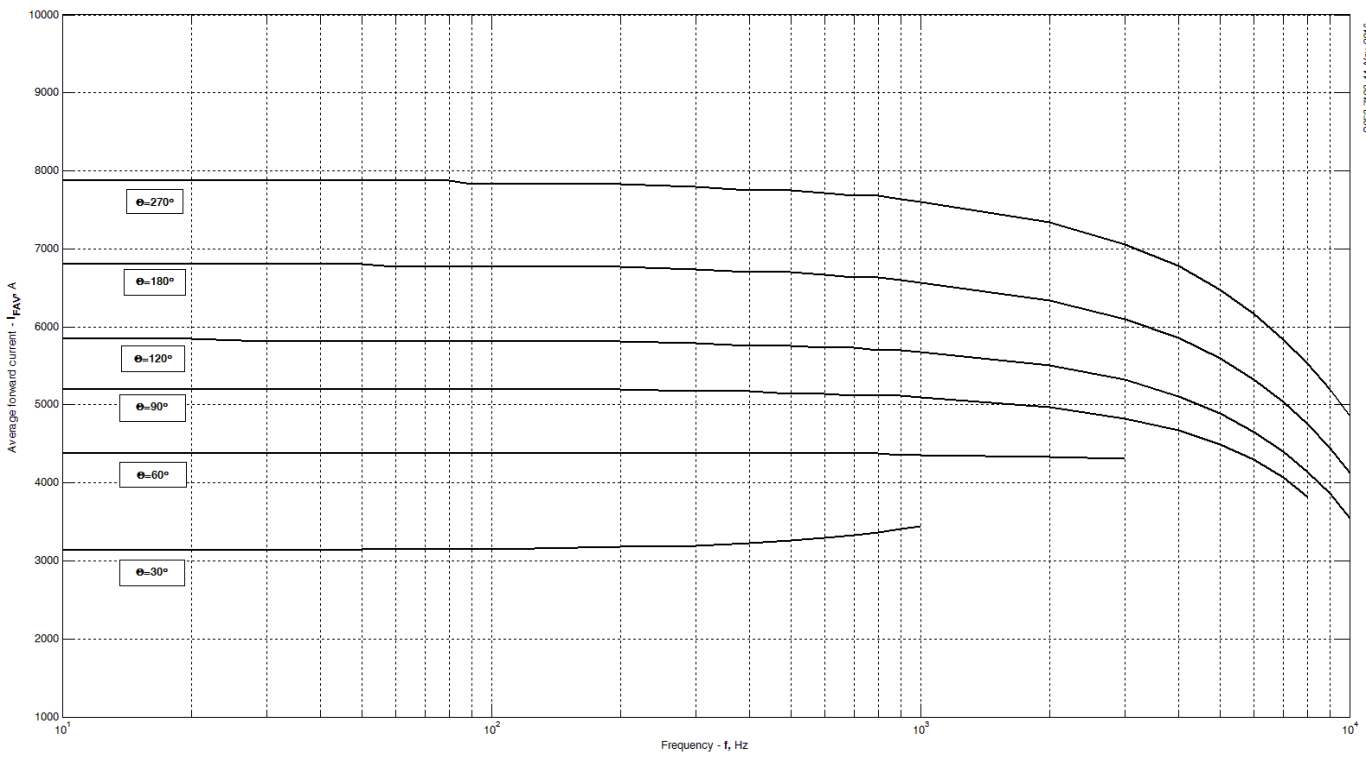
**Fig 14 – Maximum surge and  $I^2t$  ratings**



**Fig 15 – Maximum surge ratings**



**Fig 16 – Maximum forward current vs. frequency, trapezoid waveform, T<sub>C</sub>=85 °C, di<sub>F</sub>/dt=±500 A/μs, V<sub>R</sub>=100 V**



**Fig 17 –Average forward current vs. frequency, trapezoid waveform,  
T C =85 °C, di<sub>F</sub>/dt=±500 A/μs, V<sub>R</sub> =100 V**